

AUTORAIN



*** nur im Set erhältlich / only available in Set**

Teile ohne Bestell Nr. sind keine E-Teile.

Preis und Lieferzeit nur auf Anfrage.

Parts without Part No. are not available as Spare Part.

Price and delivery time only on request.



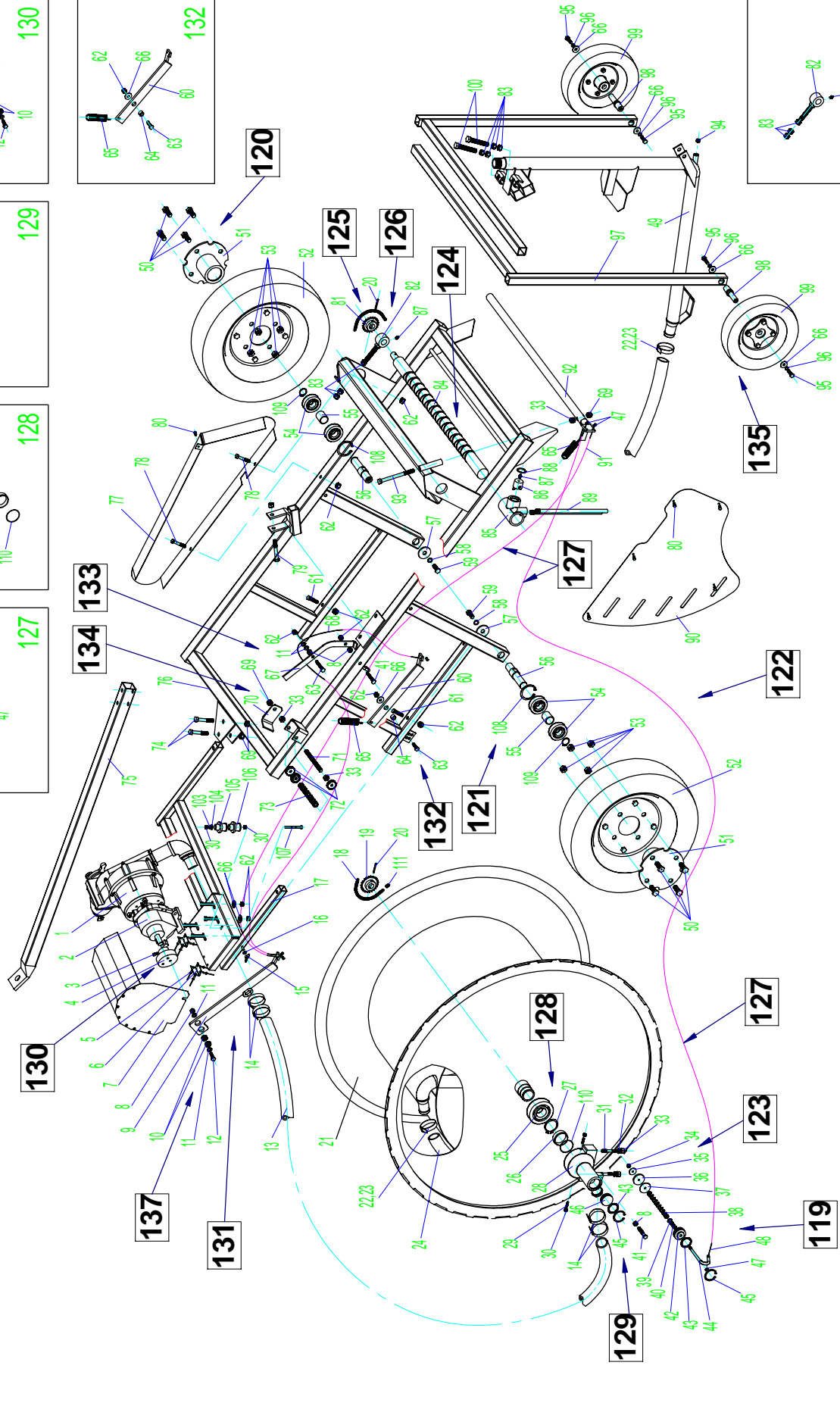
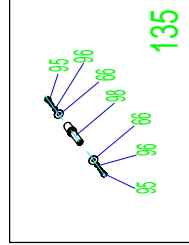
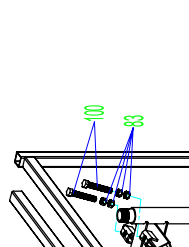
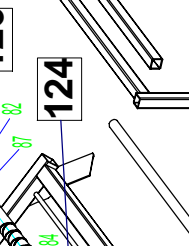
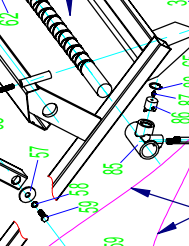
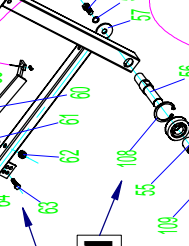
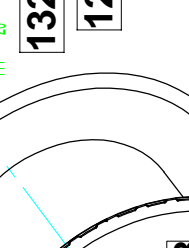
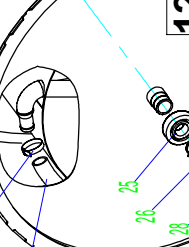
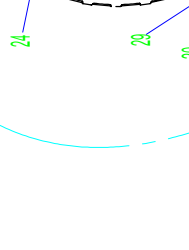
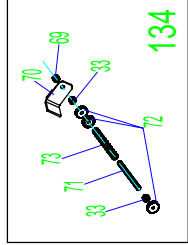
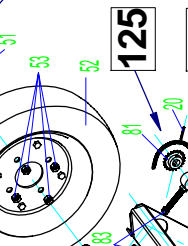
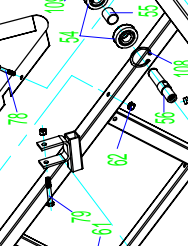
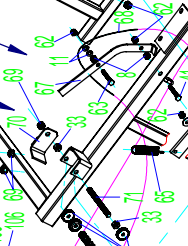
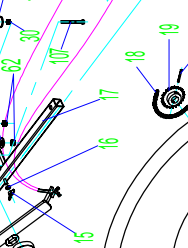
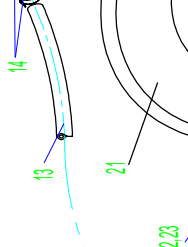
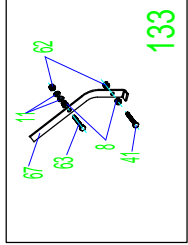
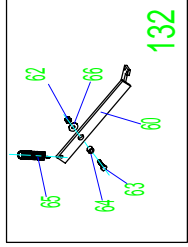
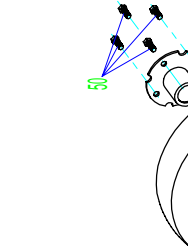
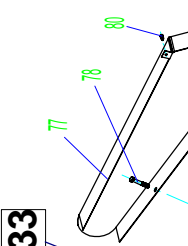
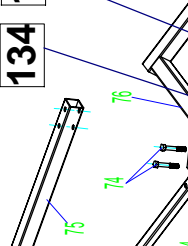
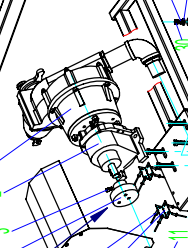
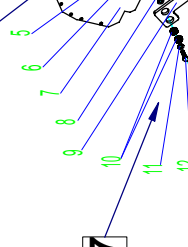
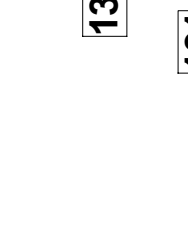
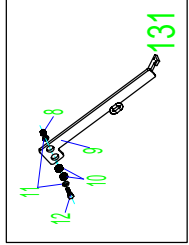
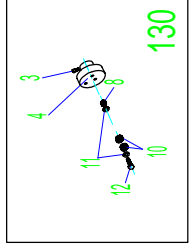
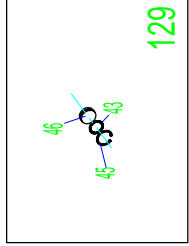
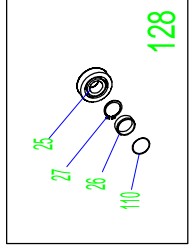
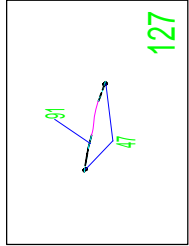
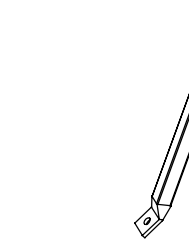
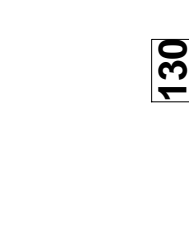
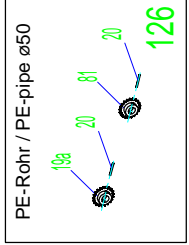
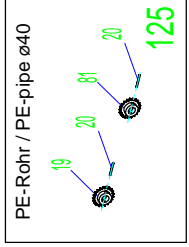
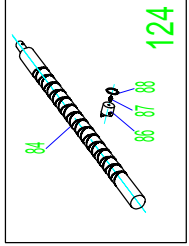
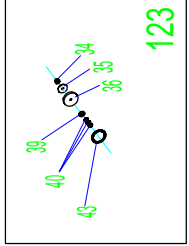
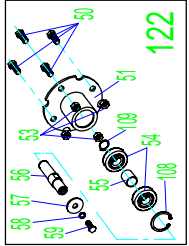
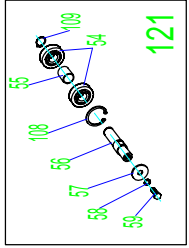
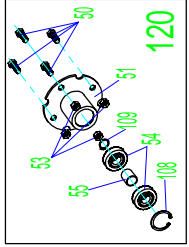
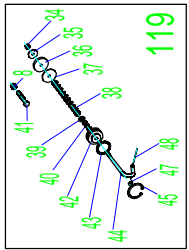

ERSATZTEILISTE
LIST OF SPARE PARTS
LISTE DES PIÈCES DE RECHANGE

AUTORAIN

Bild Fig. Rep.	Bestell Nr. Part No. Reference	Benennung Description Designation	Stück quant. pieces	Stück quant. pieces
			AUTORAIN 40	AUTORAIN 50
1	834 3670	Turbine	1	1
2	834 3671	Getriebe / Gear box	1	1
3	*	Schr. / Hex. screw DIN 916 - M5x10	1	1
4	*	Antriebscheibe / Driving plate	1	1
5		Blind Niet / Rivet GB12618-90 4x13	8	8
6		Scharnier / Hinge GB7277-87 50x38	2	2
7		Abdeckung Getriebe / Gear box cover	1	1
8	*	Skt. Mutter / Hex. nut DIN 934-M8	4	4
9	*	Antriebsklinke / Driving claw	1	1
10	*	Rillenkugellager / Grooved ball bearing 608-2RS	2	2
11	*	Scheibe / Washer DIN 126-9	4	4
12	*	Skt. Schr. / Hex. bolt DIN 933-M8x25	1	1
13		Schlauch / Hose 32x5x1,1m	1	1
14		Schlauchschele / Hose clamp DIN 3017-035-050/13	4	4
15		Flügelmutter / Butterfly nut GB62-88 M6	1	1
16		Scheibe / Washer DIN 125-6,4	1	1
17		Antriebsrahmen / Drive plate	1	1
18	061 8384	Kette / Chain DIN8187-05B-1, 167 links	1	1
19	*	Kettenrad / Sprocket wheel 8x3, Z=23	1	-
19a	*	Kettenrad / Sprocket wheel 8x3, Z=29	-	1
20	*	Spannstift / Dowel pin DIN1481-4x35	2	1
	*	Spannstift / Dowel pin DIN1481-4x40	-	1
21		Haspel / Reel 40	1	-
		Haspel / Reel 50	-	1
22		Band / Steel Band 3/4"	0.6m	0.7m
23		Schlaufe / Band lock 3/4"	2	2
24		PE-Rohr / PE-pipe 40x3.5x120m	1	-
		PE-Rohr / PE-pipe 50x5.0x74m	-	1
25	*	Rillenkugellager / Grooved ball bearing 6009-2RS	1	1
26	*	Sicherungsring / Retaining ring DIN471-45x1.75	1	1
27	*	Dichtbüchse / Bushing	1	1
28	834 3520	Dichtungsteil / Sealing retainer	1	1
29		Schr. / Hex. screw DIN915-M6x20	2	2
30		Skt. Schr. / Hex. nut DIN 934-M6	4	4
31		Stiftschr. / Threaded stud DIN835-M10x20	2	2
32		Federring / Spring washer DIN127-B10	2	2
33	*	Skt. Mutter / Hex. nut DIN934-M10	5	5
34	*	Skt. Mutter / Hex. nut DIN980-M5	1	1
35	*	Scheibe / Washer ø25	1	1
36	*	Dichtung / Seal packing	1	1
37	*	Scheibe / Washer ø38	1	1

*** nur im Set erhältlich / only available in Set**

Teile ohne Bestell Nr. sind keine E-Teile. Preis und Lieferzeit nur auf Anfrage.

Parts without Part No. are not available as Spare Part. Price and delivery time only on request



ERSATZTEILISTE
LIST OF SPARE PARTS
LISTE DES PIECES DE RECHANGE

AUTORAIN

Bild Fig. Rep.	Bestell Nr. Part No. Reference	Benennung Description Designation	Stück quant. pieces	Stück quant. pieces
			AUTORAIN 40	AUTORAIN 50
38	*	Feder / Spring	1	1
39	*	Scheibe / Washer DIN125-A8.4	1	1
40	*	O-ring 8x2	3	3
41	*	Skt. Schr. / Hex. bolt DIN933-M8x60	2	2
42	*	Führungsteil / Casing cap	1	1
43	*	O-ring 34.2x3	2	2
44	*	Schaltbügel / Piston rod	1	1
45	*	Sicherungsring / Retaining ring DIN472-40x1.75	2	2
46	*	Verschlussscheibe / Casing cap	1	1
47	*	Seilklemme / Clip of wire rope 2mm ²	6	6
48	*	Seil / Wire rope DIN3055 ø1.5 (Set Nr./ Set No. 127)	0.8m	0.8m
49		Stativrohr / cart hose 40	1	
		Stativrohr / cart hose 50		1
50	*	Skt. Schr. / Hex. bolt DIN933-M12x1.25x25	8	8
51	*	Radnabe / Wheel hub	2	2
52	834 3672	Rad / Tire 5.00-8.4PR	2	2
53	*	Skt. Mutter / Hex. nut DIN934-M12x1.25	8	8
54	*	Rillenkugellager / Grooved ball bearing 6205 2RS	4	4
55	*	Hülse / Sleeve	2	2
56	*	Achse / Stub axle	2	2
57	*	Scheibe / Washer DIN440-R13.5	2	2
58	*	Federring / Spring washer DIN127-B12	2	2
59	*	Skt. Schr. / Hex. bolt DIN933-M12x30	2	2
60	*	Sperrklinke / Claw	1	1
61		Skt. Schr. / Hex. bolt DIN933-M8x40	2	2
62	*	Skt. Mutter / Hex. nut DIN980-M8	11	11
63	*	Skt. Schr. / Hex. bolt DIN933-M8x30	6	6
64	*	Lagerbüchse / Copper bushing	1	1
65	*	Feder / Spring	2	2
66	*	Scheibe / Washer DIN440-R9	9	9
67	*	Entriegelungshebel / Joy stick	1	1
68	*	Seil / Wire rope DIN3055 ø1.5 (Set Nr./ Set No. 127)	1m	1m
69	*	Skt. Mutter / Hex. nut DIN980-M10	5	5
70	*	Bremse / Brake	1	1
71	*	Gew. Stange / Threaded rod M10x135	1	1
72	*	Rändelmutter / Milled nut DIN467-M10	3	3
73	*	Feder / Spring	1	1
74		Skt. Schr. / Hex. bolt DIN933-M10x60	2	2
75		Deichsel / Drawbar	1	1
76		Rahmen / Undercarriage	1	1
77		Kettenschutz / Chain guard	1	1

*** nur im Set erhältlich / only available in Set**

Teile ohne Bestell Nr. sind keine E-Teile. Preis und Lieferzeit nur auf Anfrage.

Parts without Part No. are not available as Spare Part. Price and delivery time only on request

ERSATZTEILISTE
LIST OF SPARE PARTS
LISTE DES PIÈCES DE RECHANGE

AUTORAIN

Bild Fig. Rep.	Bestell Nr. Part No. Reference	Benennung Description Designation	Stück quant. pieces	Stück quant. pieces
			AUTORAIN 40	AUTORAIN 50
78		Skt. Schr. / Hex. bolt DIN933-M8x55	2	2
79		Skt. Schr. / Hex. Bolt DIN931-M10x70	1	1
80		Blechschr. / Plate screw DIN7976-B4.8x13	6	6
81	*	Kettenrad / Sprocket wheel 8x3-Z=21	1	1
82	*	Spannschraube / Support ring	1	1
83	*	Skt. Mutter / Hex. nut DIN934-M12	6	6
84	*	Wendelnutspindel / Helically grooved spindle	1	1
85	834 3565	Führungsrohr / Guide block	1	1
86	*	Mitnehmer / Driver	1	1
87	*	Schmiernippel / Conical lubricating head AM6	2	2
88	*	Sicherungsring / Retaining ring DIN472-30x1.2	1	1
89	834 3570	Führung / Guide rod (2 Stück / pieces)	1	1
90		Abdeckung / Left cover plate	1	1
91	*	Seil / Wire rope DIN3055 ø1.5 (Set Nr./ Set No. 127)	1.2m	1.2m
92	834 3593	Abschaltrohr / Shut-off rod	1	1
93		Skt. Schr. / Hex. bolt DIN933-M10x130	1	1
94		Stopfen / Hex. bolt M1930-1/4"-Nr.290	1	1
95	*	Skt. Schr. / Hex. bolt DIN933-M8x20	4	4
96	*	Federring / Spring washer DIN127-B8	2	2
97		Radträger / Wheel carrier	2	2
98	*	Achse / Stub axle	2	2
99	834 3673	Rad / Tire 260x80	2	2
100		Skt. Schr. / Hex. bolt DIN933-M12x50	2	2
103		Federring / Spring washer DIN127-B6.6	1	
104		Scheibe / Washer DIN440-R6,6	1	
105	834 3686	Düse / Nozzle 10	1	
106	834 3682	Düse / Nozzle 12	1	
107		Skt. Schr. / Hex. bolt DIN933-M6x80	1	
108	*	Sicherungsring / Retaining ring DIN472-25x1.2	2	2
109	*	Sicherungsring / Retaining ring DIN471-52x2	2	2
110	*	Nutring / Grooved ring N 50-62-6-3 70SH	1	1
111	061 8324	Glied / Link DIN 8187 - 05 B - 1	1	1

*** nur im Set erhältlich / only available in Set**

Teile ohne Bestell Nr. sind keine E-Teile. Preis und Lieferzeit nur auf Anfrage.

Parts without Part No. are not available as Spare Part. Price and delivery time only on request

ERSATZTEILISTE
LIST OF SPARE PARTS
LISTE DES PIECES DE RECHANGE

AUTORAIN

Bild Fig. Rep.	Bestell Nr. Part No. Reference	Benennung Description Designation	Stück quant. pieces	Stück quant. pieces
			AUTORAIN 40	AUTORAIN 50
119	834 2970	SET: Wasserstop / Water stop	1	1
120	834 2971	SET: Radlagerung / Wheel hub-bearing	2	2
121	834 2972	SET: Achse-Lagerung / Axle-bearing	2	2
122	834 2973	SET: Radlagerung mit Achse / Wheel hub-bearing with Axle	2	2
123	834 2974	SET: Dichtungen Wasserstop / Sealing Water stop	1	1
124	834 2975	SET: Wendelnutspindel m. Mitnehmer / Helically grooved spindle with Driver	1	1
125	834 2976	SET: Kettenrad / Sprocket wheel z=21/23	1	-
126	834 2977	SET: Kettenrad / Sprocket wheel z=21/29	-	1
127	834 2978	SET: Seil / Wire rope	1	1
128	834 2979	SET: Haspellager m. Dichtung / Reel bearing with sealing	1	1
129	834 2980	SET: Verschußscheibe / Casing cap	1	1
130	834 2981	SET: Antriebsscheibe / Driving plate	1	1
131	834 2982	SET: Antriebsklinke / Driving claw	1	1
132	834 2983	SET: Sperrklinke / Claw	1	1
133	834 2984	SET: Entriegelungshebel / Joy stick	1	1
134	834 2985	SET: Bremse / Brake	1	1
135	834 2986	SET: Achse Stativ / Axle wheelcart	2	2
136	834 2987	SET: Mitnehmer / Driver	1	1
137	834 2988	SET: Bef. Teile für Klinken mit Feder / Mounting parts for claw with spring	2	2
138	834 2989	SET: Spannschraube / Support	1	1

*** nur im Set erhältlich / only available in Set**

Teile ohne Bestell Nr. sind keine E-Teile. Preis und Lieferzeit nur auf Anfrage.

Parts without Part No. are not available as Spare Part. Price and delivery time only on request

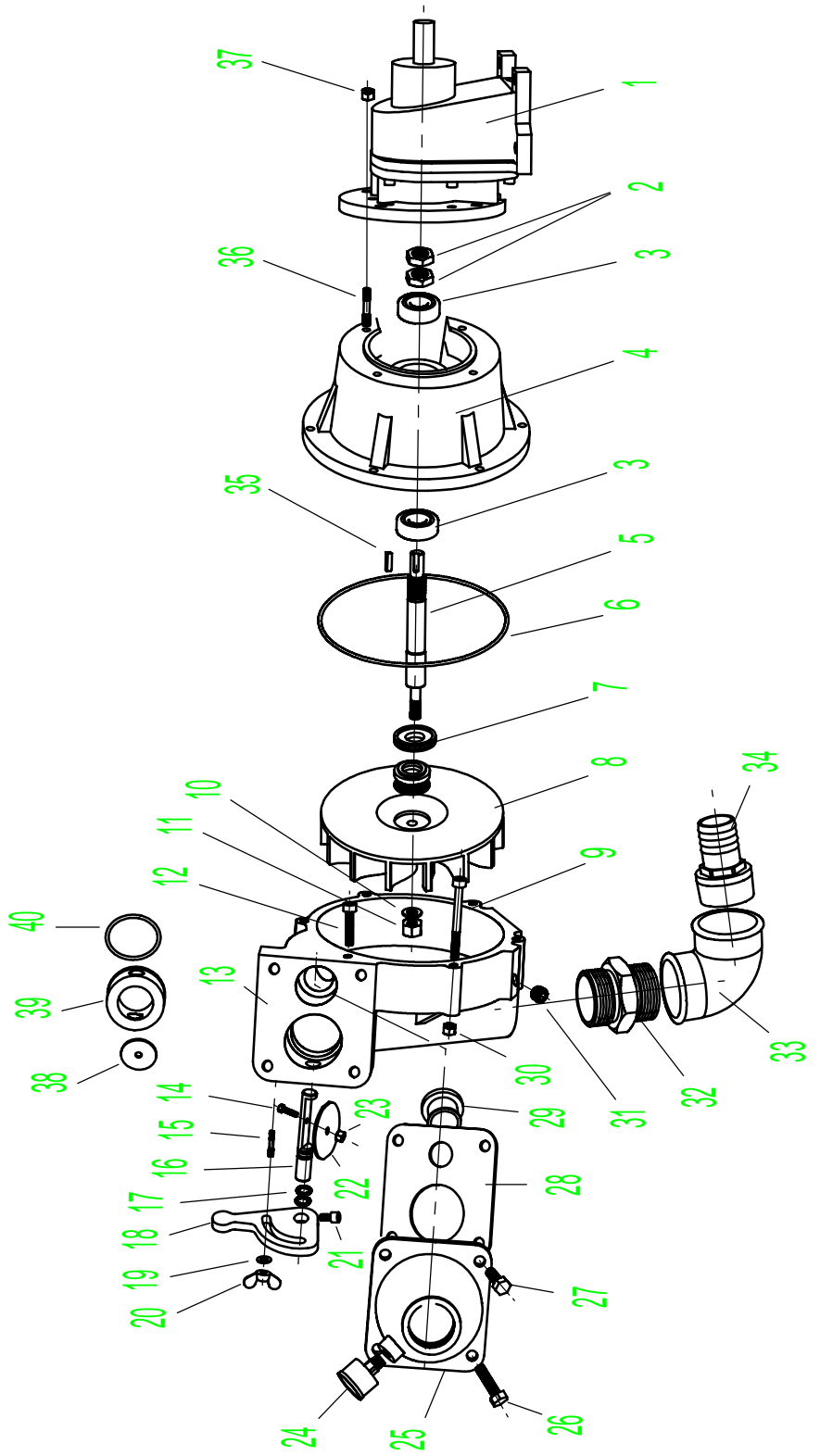
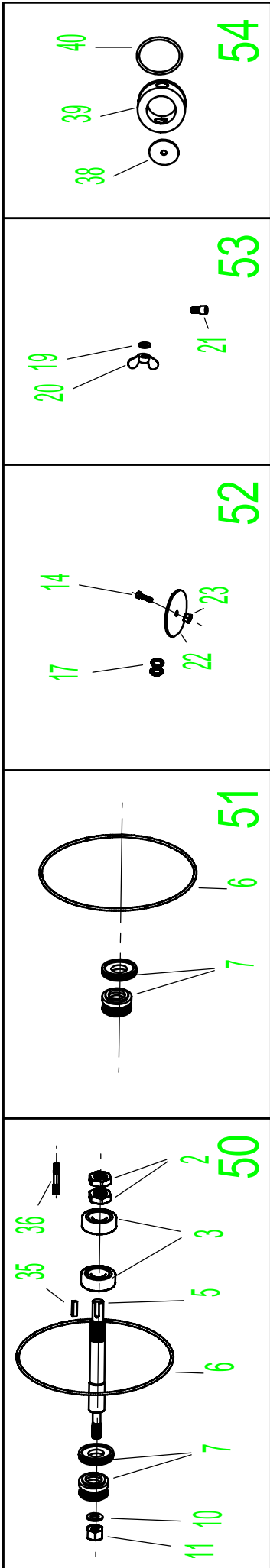

ERSATZTEILISTE
LIST OF SPARE PARTS
LISTE DES PIECES DE RECHANGE

AUTORAIN
Turbine

Bild Fig. Rep.	Bestell Nr. Part No. Reference	Benennung Description Designation	Stück quant. pieces	Stück quant. pieces
			AUTORAIN 40	AUTORAIN 50
1	834 3671	Getriebe / Gear box	1	1
2	*	Skt. Mutter / Hex. nut GB/T6173-1986 M14x1.5	2	2
3	*	Rillenkugellager / Grooved ball bearing 6202-2RS	2	2
4		Lagergehäuse / Bearing seat of turbine	1	1
5	*	Turbinenwelle / Turbine shaft	1	1
6	*	O-ring GB/T3452.1-1992 155x2.65	1	1
7	*	Gleitringdichtung / Mechanical seal 16mm	1	1
8	834 3674	Turbinenlaufrad / Turbine impeller	1	1
9		Schraube / Hex. screw DIN916-M6x65	5	5
10	*	Washer DIN125-8.4	1	1
11	*	Skt. Mutter / Hex. nut DIN980-M8	1	1
12		Schraube / Hex. screw DIN916-M6x30	1	1
13	834 3675	Turbinengehäuse / turbine housing	1	1
14	*	Skt. Schr. / Hex. bolt DIN933-M5x20	1	1
15		Gew. Stift / threaded stud DIN835-M6x22	1	1
16		Regelwelle / Regulating shaft	1	1
17	*	O-ring GB/T3452.1-1992 8.75x1.8	2	2
18		Regelhebel / Regulating panel	1	1
19	*	Scheibe / Washer DIN125-6.4	1	1
20	*	Flügelmutter / Butterfly nut GB/T62-1988 M6	1	1
21	*	Scharube / Hex. screw DIN916-M5x10	1	1
22	*	Regelscheibe / Regulating flap	-	1
23	*	Skt. Mutter / Hex. nut DIN980-M5	1	1
24	831 3236	Manometer / Pressure gauge	1	1
25		Einlaufgehäuse / Inlet bend	1	1
26		Skt. Schr. / Hex. bolt DIN933-M8x30	3	3
27		Skt. Schr. / Hex. bolt DIN933-M8x20	1	1
28		Dichtung / Sealing	1	1
29	834 3683	Düse / Nozzle 9	1	-
	834 3688	Düse / Nozzle 18	-	1
30		Skt. Mutter / Hex. nut DIN934-M6	5	5
31		Schraube / Hex. bolt DIN 906-R1/4	1	1
32		Doppelnippel / Straight pipe tie-in 1 1/2"	1	1
33		Bogen / Angle coupling 1 1/2"	1	1
34		Schlauchtülle / Outlet	1	1
35		Paßfeder / Key DIN6885-4x15	1	1
36	*	Stiftschraube / Threaded stud DIN835-M8x22	4	4
37		Skt. Mutter / Hex. nut DIN934-M8	4	4
38	*	Regelscheibe / Regulating flap	1	-
39	*	Reduktion / reduction	1	-
40	*	O-ring GB/T3452.1-1992 34.7x2.65	1	-
50	834 2990	SET: Welle-Lager-Gleitringdichtung/Axle-bearing-mechan.seal	1	1
51	834 2991	SET: Gleitringdichtung, O-Ring / Mechan.seal, O-ring	1	1
52	834 2992	SET: Regelscheibe, O-Ring / Regulating flap, O-ring	1	1
53	834 2993	SET: Bef.Teile für Regelhebel/Mounting parts for Regulating shaft	1	1
54	834 2994	SET: Reduktion / reduction	1	1

*** nur im Set erhältlich / only available in Set**

Teile ohne Bestell Nr. sind keine E-Teile. Preis und Lieferzeit nur auf Anfrage.

Parts without Part No. are not available as Spare Part. Price and delivery time only on request

